



A division of
WGI Westman Group Inc.



Tunnel Liner Plate

Segmented corrugated steel plate
for lining soft ground tunnels
and relining existing conduits.



Tunnel Liner Plate

A COST-EFFECTIVE SOLUTION FOR **BRINGING OLD STRUCTURES BACK TO LIFE!**

Tunnel Liner Plate is one of the most versatile segmental corrugated steel plate systems on the market today. Designed specifically for lining soft ground tunnels and relining existing conduits under highways and railroads, its applications extend to caissons, vertical shafts, mine entries and much more. Since complex tunnel lining equipment is not required, installation is quick and easy with minimal disruption to road users and the surrounding environment.

Tunnel Liner Plate is available in three curved lengths allowing configuration of a variety of shapes and sizes, from 1.3m to 8m in diameter. Its two-flange design has twice the effective stiffness of a four-flange plate system in the same gauge (thickness). Individual plates weigh between 15 and 41 kg - light enough to carry by hand into a confined space. A variety of material options and coatings are available to optimize service life requirements.

Assembly is simple using “speed bolts” (square-shouldered bolts and holes) at the flange connection. Plates can be assembled from inside the tunnel in continuous rings, advancing tunnels in 500mm long segments and grouted at regular intervals via factory-installed grout ports. As the tunnel progresses, the liner plate continually generates ring support, providing a safe launch area for workers and equipment to advance.

TYPICAL APPLICATIONS

- Tunnels
- Relines of Existing Structures
- Vertical Shafts
- Mine Entries
- Vertical Storage Bins
- Caissons
- Rock-fall Protection
- Soft Ground Tunneling

ADDITIONAL APPLICATIONS

- Pipe relines where access is only available from inside the liner
- Pipe relines with vertical or horizontal changes in alignment (sharp turns)



VERSATILE

Many shapes and sizes are available for horizontal or vertical installation



LIGHTWEIGHT

Individual plates can be carried by a single person, ideal for challenging locations



ECONOMICAL

A cost effective solution for the rehabilitation of failing structures



SAFE

Once securely grouted into place, all underground work can be carried out safely within the assembled shell



QUICK INSTALLATION

With only two basic parts (plates and fasteners) no special skills are required for assembly

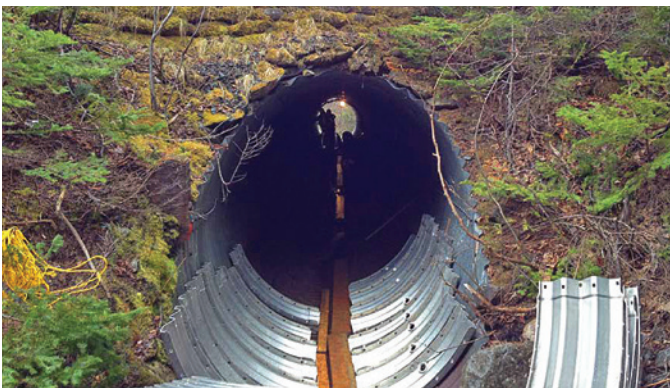

THE USE OF TUNNEL LINER MINIMIZED ENVIRONMENTAL IMPACT AT THE TERRA NOVA NATIONAL PARK, NEWFOUNDLAND

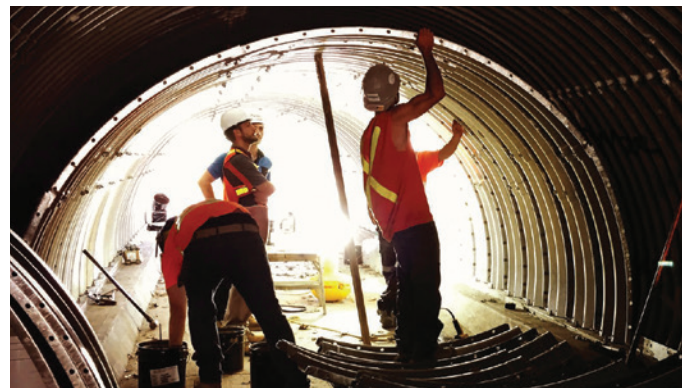

SAFE AND EFFICIENT INSTALLATION IS CARRIED OUT FROM WITHIN THE ASSEMBLED SHELL

Options Available

TWO COMPONENTS	Curved corrugated two-flange steel plates, punched to suit 16mm diameter "speed bolts" as per ASTM A307
PLATE THICKNESS	3.0mm, 4.0mm, 5.0mm, 6.0mm
FINISH	<ul style="list-style-type: none"> Galvanized Aluminum Strata-CAT Black Steel
SHAPES	<ul style="list-style-type: none"> Round Pipe Arch Elliptical Arch Underpass
SIZES	500mm wide x 300pi-mm (942mm) 500mm wide x 350pi-mm (1100mm)* 500mm wide x 400pi-mm (1257mm)
DESIGN METHOD	AASHTO Standard Specification for Highway Bridges, Division I, Section 16

*350pi-mm plates are available as special order, please contact an Armtec representative

FIGURE 1: Tunnel Liner Plate corrugation profile

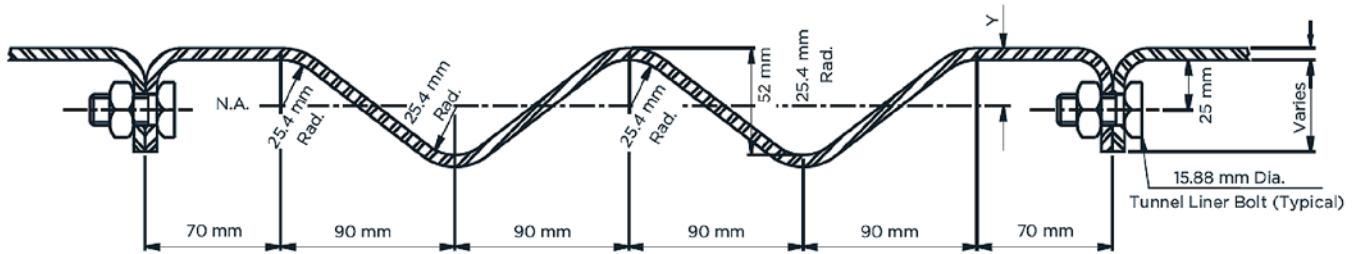

Tunnel Liner Plate Shapes

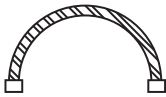

Single Radius Arch



Two Radius Arch

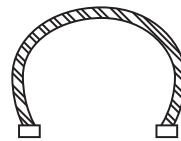

Three Radius Arch



Round



Pipe Arch

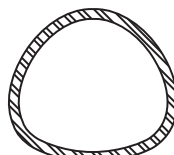

Underpass

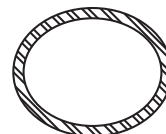

Horizontal Ellipse

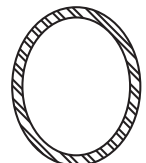

Vertical Ellipse

Tunnel Liner Plate Components

All Armtec Tunnel Liner Plates have a covering width of 500mm (along the centre line of the tunnel). Two plate lengths of 300pi-mm and 400pi-mm enable diameters ranging from 1,300mm to 8,000mm in increments of 100mm diameter.

Circumferential seams are made by butting adjacent plate flanges and bolting the plates together from the inside. Longitudinal seams (end of the plate) are overlapped by means of a 'swaged' and/or a 'non-swaged' end. Bolts are used to secure the lap (see Figure 3). Longitudinal seams are staggered from one ring to the next to provide greater overall strength to the structure.

To facilitate complete assembly from within the finished structure, the top centre plate (also known as the 'starting plate') has two non-swaged ends. The bottom centre plate (also known as the 'finishing plate') has two swaged ends.

TUNNELING VS. CUT AND COVER

Tunneling is most often performed when the ground surface cannot be cut open. This may be due to traffic, existing buildings or structures, or space and/or clearance restrictions. Tunneling applications can include drainage or utilities in urban areas, under highways or railways.

FIGURE 2: Three plates types

FIGURE 3: Bolting configuration

N | **No Swage**
Both ends are plain and punched with square holes.

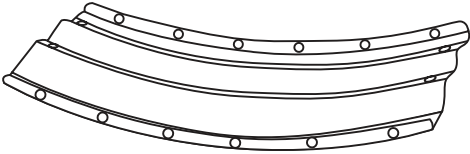

S | **Single Swage**
One end is swaged to fit into the adjacent plate and punched with slotted holes; the other end is plain and punched with square holes.

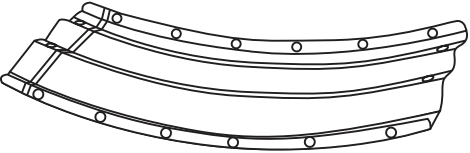

D | **Double Swage**
Each end is swaged and punched with slotted holes.

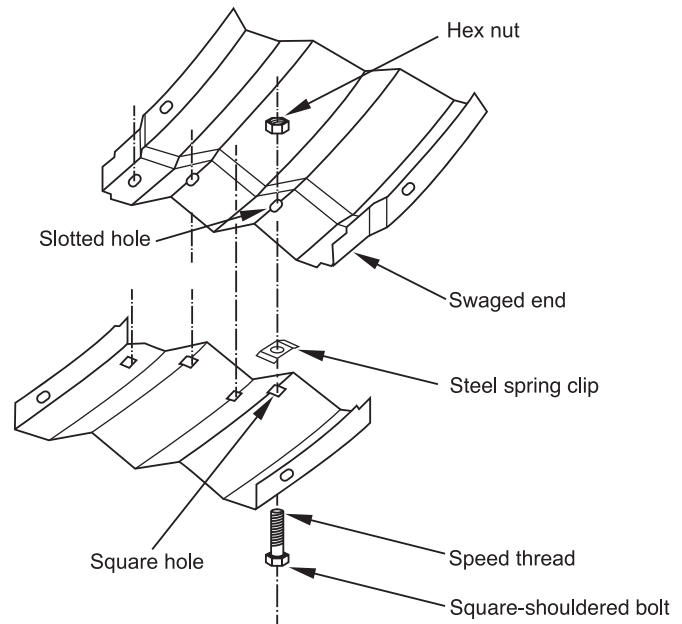
Typical Layout of Tunnel Liner Plate

FIGURE 4: Example of typical Tunnel Liner Plate layout

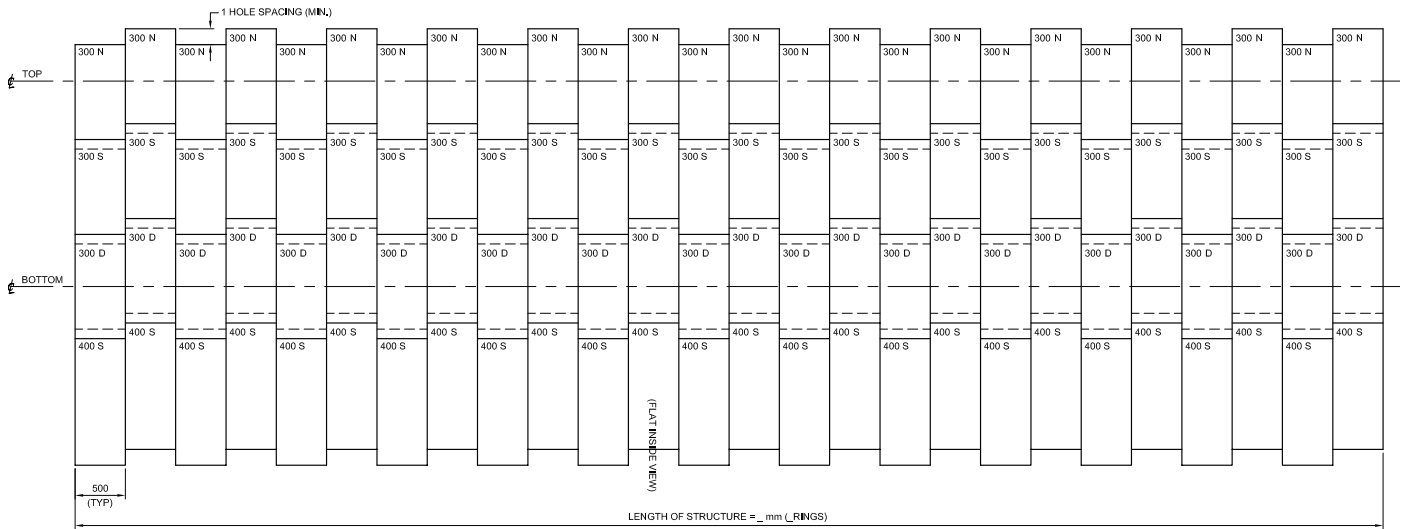

NOTE:
N = NO SWAGE **S** = SINGLE SWAGE **D** = DOUBLE SWAGE

FIGURE 5: Section of 1,300mm diameter Tunnel Liner Plate

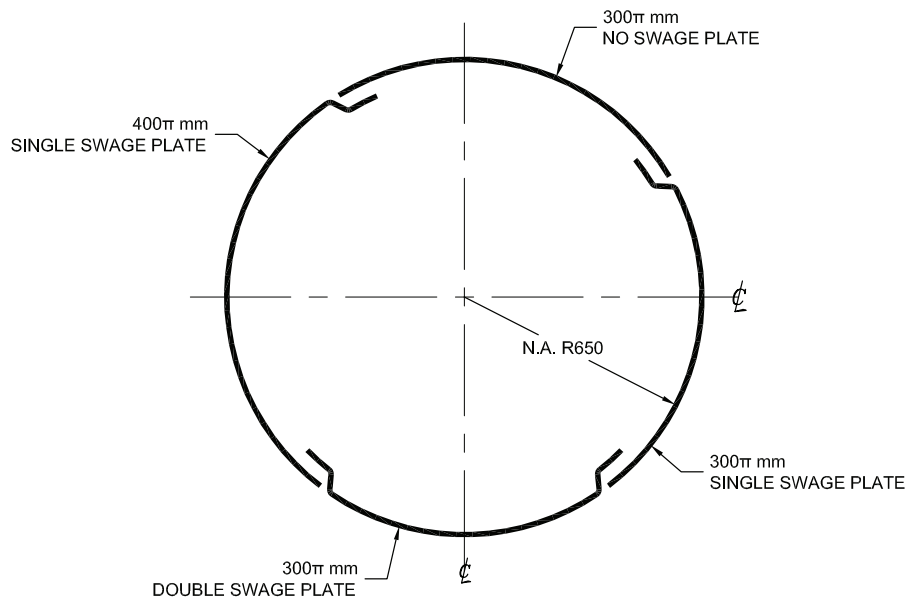

NOTES:
 1. Plate length is measured in pi-mm where 400pi-mm is equivalent to 400 x 3.14mm
 2. N.A. refers to neutral axis diameter



TUNNEL LINER PLATE SECTIONS



TUNNEL LINER PLATE IS AVAILABLE WITH STRATA-CAT POLYMER COATING FOR ADDITIONAL CORROSION PROTECTION

TABLE 1: Ultimate longitudinal seam strength of Armtec Tunnel Liner Plates

Nominal Thickness	Strength	Minimum Radius of Curvature	Bolt Size*
mm	kN/m	mm	mm x mm
3.0	497	650	ASTM A-307 - 16 X 32
4.0	802	650	ASTM A-307 - 16 X 32
5.0	1,117	1,050	ASTM A-449 - 16 X 38
6.0	1,246	1,500	ASTM A-449 - 16 X 38

*LONGITUDINAL AND CIRCUMFERENTIAL

TABLE 2: Properties and dimensions of Armtec Tunnel Liner Plates

Nominal Thickness	Design Thickness	Area	Y ¹	Moments of Inertia	SECTION MODULUS		Radius of Gyration	APPROXIMATE WEIGHTS (Single Plate)	
					Bottom	Top		300pi-mm	400pi-mm
mm	mm	mm ² /mm	mm	mm ⁴ /mm	mm ³ /mm	mm ³ /mm	mm	kg	kg
3.0	2.95	3.522	22.910	1198.77	52.32	37.42	17.84	15.73	20.53
4.0	4.00	4.776	23.556	1634.48	69.39	50.38	17.89	20.98	27.37
5.0	5.00	5.970	24.172	2054.55	85.00	62.58	17.94	26.22	34.21
6.0	6.00	7.164	24.789	2480.01	100.04	74.67	18.00	31.46	41.05
NUMBER OF BOLTS PER PLATE								11	13

NOTES: 1. Y = Distance from outer face to neutral axis (ref. FIGURE 6)



PLATES CAN BE INSTALLED VERTICALLY AS WELL AS HORIZONTALLY



SPACE REQUIREMENTS FOR STORING PRODUCT ON-SITE ARE MINIMAL



TUNNEL LINER PLATE DELIVERS MAXIMUM STRENGTH WITH MINIMUM WEIGHT

ARMTEC IS A MEMBER OF THE CORRUGATED STEEL PIPE INSTITUTE (CSPI) | **cspi**

TABLE 3: Depth of tunnel limits for CL-625 live load granular soil ($\Phi = 17^\circ$) $W=1.94\text{mg}/\text{m}^3$

Neutral Axis Diameter (mm)	Specified Thickness (mm) for Minimum and Maximum Height of Cover (m)			
	3.0 mm	4.0 mm	5.0 mm	6.0 mm
1,300	1.2m - NL	1.2m - NL		
1,500	1.2m - NL	1.2m - NL		
1,800	1.2m - NL	1.2m - NL		
2,100	1.2m - NL	1.2m - NL	1.2m - NL	1.2m - NL
2,400	1.2m - NL	1.2m - NL	1.2m - NL	1.2m - NL
2,700	1.2m - NL	1.2m - NL	1.2m - NL	1.2m - NL
3,000	1.2m - NL	1.2m - NL	1.2m - NL	1.2m - NL
3,300	1.2m - NL	1.2m - NL	1.2m - NL	1.2m - NL
3,600	1.2m - 18m	1.2m - NL	1.2m - NL	1.2m - NL
3,900	1.2m - 10m	1.2m - NL	1.2m - NL	1.2m - NL
4,200	1.2m - 4.2m	1.2m - NL	1.2m - NL	1.2m - NL
4,500	1.2m - 3.9m	1.2m - 27m	1.2m - NL	1.2m - NL
4,800	1.2m - 3.6m	1.2m - 15m	1.2m - NL	1.2m - NL
5,100		1.2m - 9.9m	1.2m - NL	1.2m - NL
5,400		1.2m - 5.2m	1.2m - 27m	1.2m - NL
5,700		1.2m - 4.9m	1.2m - 17.4m	1.2m - 28.5m
6,000		1.2m - 4.7m	1.2m - 11.4m	1.2m - 18.3m

NOTES: (Tables 3 - 6)

- NL = No Limit
- Live loads assumed negligible beyond 2.4m for CL-625 and 9.1m for E80
- A minimum limit of 1.2m cover should generally be used to prevent loss of roof materials
- Based on $K=0.22$
- Per AASHTO design method
- Values represent minimum stiffness allowable
- Actual job conditions may require greater effective stiffness

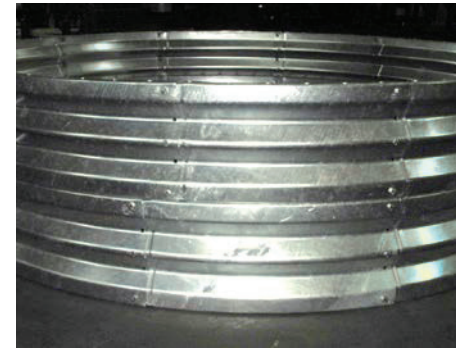

TUNNEL LINER RING

TABLE 4: Depth of tunnel limits for E80 live load granular soil ($\Phi = 17^\circ$) $W=1.94\text{mg}/\text{m}^3$

Neutral Axis Diameter (mm)	Specified Thickness (mm) for Minimum and Maximum Height of Cover (m)			
	3.0 mm	4.0 mm	5.0 mm	6.0 mm
1,300	1.2m - NL	1.2m - NL		
1,500	1.2m - NL	1.2m - NL		
1,800	1.2m - NL	1.2m - NL		
2,100	1.5m - NL	1.2m - NL	1.2m - NL	1.2m - NL
2,400	1.6m - NL	1.2m - NL	1.2m - NL	1.2m - NL
2,700	2.4m - NL	1.2m - NL	1.2m - NL	1.2m - NL
3,000	3.0m - NL	1.2m - NL	1.2m - NL	1.2m - NL
3,300	4.5m - NL	1.3m - NL	1.2m - NL	1.2m - NL
3,600	6.0m - 18m	1.5m - NL	1.2m - NL	1.2m - NL
3,900	8.0m - 10m	1.6m - NL	1.2m - NL	1.2m - NL
4,200		2.2m - NL	1.2m - NL	1.2m - NL
4,500		2.6m - 27m	1.2m - NL	1.2m - NL
4,800		3.0m - 15m	1.3m - NL	1.2m - NL
5,100		3.6m - 9.9m	1.5m - NL	1.3m - NL
5,400			1.8m - 27m	1.4m - NL
5,700			2.1m - 17.4m	1.5m - 28.5m
6,000			2.4m - 11.4m	1.6m - 18.3m

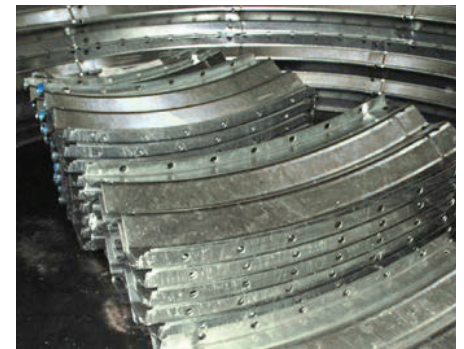

TUNNEL LINER PLATES

TABLE 5: Depth of tunnel limits for CL-625 live load saturated clay ($\Phi = 8.7^\circ$) $W=1.76\text{mg}/\text{m}^3$

Neutral Axis Diameter (mm)	Specified Thickness (mm) for Minimum and Maximum Height of Cover (m)			
	3.0 mm	4.0 mm	5.0 mm	6.0 mm
1,300	1.2m - NL	1.2m - NL		
1,500	1.2m - NL	1.2m - NL		
1,800	1.2m - NL	1.2m - NL		
2,100	1.2m - NL	1.2m - NL	1.2m - NL	1.2m - NL
2,400	1.2m - NL	1.2m - NL	1.2m - NL	1.2m - NL
2,700	1.2m - 14m	1.2m - NL	1.2m - NL	1.2m - NL
3,000	1.2m - 8.3m	1.2m - NL	1.2m - NL	1.2m - NL
3,300	1.2m - 5.9m	1.2m - 22m	1.2m - NL	1.2m - NL
3,600	1.2m - 4.8m	1.2m - 14.2m	1.2m - 42m	1.2m - NL
3,900	1.2m - 4.5m	1.2m - 9.9m	1.2m - 26m	1.2m - 38m
4,200	1.2m - 4.2m	1.2m - 7.4m	1.2m - 17.6m	1.2m - 24m
4,500	1.2m - 3.9m	1.2m - 6.3m	1.2m - 12.4m	1.2m - 17.8m
4,800	1.2m - 3.6m	1.2m - 5.8m	1.2m - 9.8m	1.2m - 13.6m
5,100	1.2m - 3.4m	1.2m - 5.5m	1.2m - 8.2m	1.2m - 10.2m
5,400		1.2m - 5.2m	1.2m - 7.3m	1.2m - 8.6m
5,700		1.2m - 4.9m	1.2m - 6.9m	1.2m - 7.7m
6,000		1.2m - 4.7m	1.2m - 6.5m	1.2m - 7.3m

TABLE 6: Depth of tunnel limits for E80 live load saturated clay ($\Phi = 8.7^\circ$) $W=1.76\text{mg}/\text{m}^3$

Neutral Axis Diameter (mm)	Specified Thickness (mm) for Minimum and Maximum Height of Cover (m)			
	3.0 mm	4.0 mm	5.0 mm	6.0 mm
1,300	1.2m - NL	1.2m - NL		
1,500	1.2m - NL	1.2m - NL		
1,800	1.2m - NL	1.2m - NL		
2,100	1.5m - NL	1.2m - NL	1.2m - NL	1.2m - NL
2,400	1.6m - NL	1.2m - NL	1.2m - NL	1.2m - NL
2,700	2.4m - 14m	1.2m - NL	1.2m - NL	1.2m - NL
3,000	3.0m - 6m	1.2m - NL	1.2m - NL	1.2m - NL
3,300		1.3m - 22m	1.2m - NL	1.2m - NL
3,600		1.5m - 14.2m	1.2m - 42m	1.2m - NL
3,900		1.6m - 9.9m	1.2m - 26m	1.2m - 38m
4,200		2.2m - 5.9m	1.2m - 17.6m	1.2m - 24m
4,500		2.6m - 4.8m	1.2m - 12.4m	1.2m - 17.8m
4,800		3.0m - 3.7m	1.3m - 9.8m	1.2m - 13.6m
5,100			1.5m - 7m	1.3m - 10.2m
5,400			1.8m - 6.3m	1.4m - 7.6m
5,700			2.1m - 6.1m	1.5m - 7.1m
6,000			2.4m - 5.7m	1.6m - 6.6m



TUNNEL LINER PLATE EARLY INSTALLATION



TUNNEL LINER PLATE'S LIGHT WEIGHT MADE IT EASY TO HAND-CARRY SECTIONS TO THIS RESTRICTED ACCESS LOCATION IN TERRA NOVA NATIONAL PARK

For full case study, visit
ARMTEC.COM

TABLE 7: Table of available diameters and dimensions, including numbers of specific types of plates required

Neutral Axis Diameter	Approx. Inside Diameter	Approx. Outside Diameter	Approx. Outside Area	Total Plates Required	No. of 300 pi-plates	No. of 400 pi-plates
mm	mm	mm	m ²			
1,300	1,240	1,350	1.43	4	3	1
1,400	1,340	1,450	1.65	4	2	2
1,500	1,440	1,550	1.89	4	1	3
1,600	1,540	1,650	2.14	4		4
1,700	1,640	1,750	2.41	5	3	2
1,800	1,740	1,850	2.69	5	2	3
1,900	1,840	1,950	2.99	5	1	4
2,000	1,940	2,050	3.30	5		5
2,100	2,040	2,150	3.63	6	3	3
2,200	2,140	2,250	3.98	6	2	4
2,300	2,240	2,350	4.34	6	1	5
2,400	2,340	2,450	4.71	6		6
2,500	2,440	2,550	5.11	7	3	4
2,600	2,540	2,650	5.52	7	2	5
2,700	2,640	2,750	5.94	7	1	6
2,800	2,740	2,850	6.38	7		7
2,900	2,840	2,950	6.83	8	3	5
3,000	2,940	3,050	7.31	8	2	6
3,100	3,040	3,150	7.79	8	1	7
3,200	3,140	3,250	8.30	8		8
3,300	3,240	3,350	8.81	9	3	6
3,400	3,340	3,450	9.35	9	2	7
3,500	3,440	3,550	9.90	9	1	8
3,600	3,540	3,650	10.46	9		9
3,700	3,640	3,750	11.04	10	3	7
3,800	3,740	3,850	11.64	10	2	8
3,900	3,840	3,950	12.25	10	1	9
4,000	3,940	4,050	12.88	10		10
4,100	4,040	4,150	13.53	11	3	8
4,200	4,140	4,250	14.19	11	2	9
4,300	4,240	4,350	14.86	11	1	10
4,400	4,340	4,450	15.55	11		11
4,500	4,440	4,550	16.26	12	3	9
4,600	4,540	4,650	16.98	12	2	10



TUNNEL LINER PLATE CAN BE USED TO LINE A VARIETY OF SHAPES, INCLUDING OPEN BOTTOM STRUCTURES

FIGURE 6: Typical plate make-up for a 2,200 neutral axis diameter

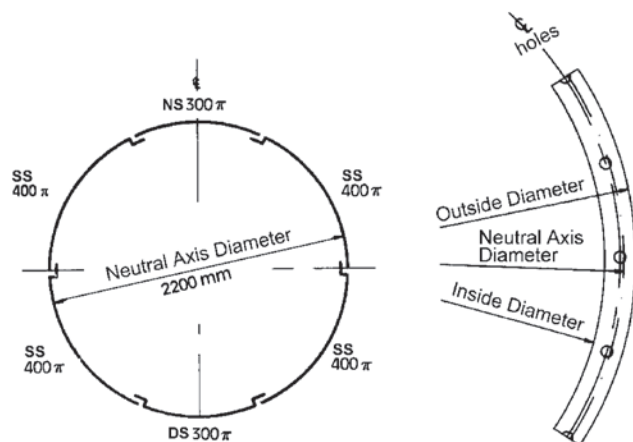

NOTE:

Diameters are available greater than those shown. Structures are designed for 100mm stagger in longitudinal seams in alternate rings. All round structures are supplied with one double and one no-swage plate per ring. Diameters are also available in increments of 50mm if required.

Assembly and Installation

Tunnel Liner Plate is assembled from within the progressing structure. This is possible due to the bolted flanged circumferential seams, and the use of spring clips and bolts at the longitudinal seams. All components can be safely hand-carried into the assembly area.

Full assembly from inside the completed portion of the structure makes Tunnel Liner Plate one of the safest products available for soft ground tunneling. Small plates (500mm wide) allow minimal unsupported excavation. In poor soils, this can be as little as the excavation required to install a single plate.

For greater efficiency, excavation should permit installation of a complete ring. Minimal over-excavation is required as all connections are made from within the finished portion of the structure. The excavation requires room to sufficiently allow assembly of the plates, while limiting the risk of impact on the structure due to settlement above. The recommended bolt torque is 135 Nm - 170 Nm.

Widely varying soil conditions require a full geotechnical investigation before the Tunnel Liner Plate structure can be properly designed (and installed). Project-specific soil type, dead loads, live loads and potential hydrostatic pressure are key to determining the requirement for plate thickness.

Installation methods are determined by the soil property and behaviour, as well as the depth of bury and the presence of live loads over the tunneling site. The stability of the finished structure relies on grouting the Tunnel Liner Plate once in place. Refer to Table 8 for guidance on installation method selection. Armtec provides layout and assembly drawings with every order.

TABLE 8: Determining an Installation Method

SITUATION	POSSIBLE SOLUTION
Clays and cohesive soils above water table	Excavation of one full ring (500mm) at tunnel face
Partially cohesive soils	<ul style="list-style-type: none">• Reduce excavation at tunnel face to allow for installation of partial ring• Consider using poling plates at crown
Low cover (shallow burial)	Use poling plates or shielding at crown
Moderate cover / live load	Use poling plates or shielding at crown
High water table	Dig sump and dewater at all times
Very deep burial	Over-excavate at tunnel face to allow for “tunnel contraction”

Grouting and Completing the Installation

After installation in the excavated tunnel or shaft line, Tunnel Liner Plate must be grouted into place. Furthermore, it is recommended that grouting takes place at the end of every shift in lifts (i.e. a single lift is not recommended). Factory-installed grout ports allow completion of this work from within the structure.

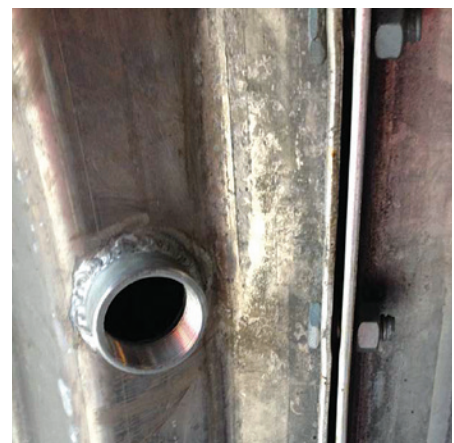

TUNNEL LINER GROUT PORT



Armtec is environmentally conscious
by supporting limited paper usage.

ATLANTIC

- Shediac, NB
- Sackville, NB
- Truro, NS
- Bishop's Falls, NL
- St. John's, NL

CENTRAL

- Cambridge, ON
- Comber, ON
- Forest, ON
- Guelph, ON
- Orangeville, ON
- Peterborough, ON
- Sudbury, ON
- Thunder Bay, ON
- Walkerton, ON
- Woodstock, ON
- St-Augustin, QC
- St-Clet, QC

PRAIRIES

- Calgary, AB
- Edmonton, AB
- Grande Prairie, AB
- Ponoka, AB
- Redwater, AB
- Winnipeg, MB
- Regina, SK
- Saskatoon, SK

WESTERN

- Dawson Creek, BC
- Genelle, BC
- Langley, BC
- Nanaimo, BC
- Prince George, BC



Platinum member

Find out how **Tunnel Liner Plate** can be used on your next project.

Call **1-800-565-1152** or visit **armtec.com**